

SAN MARTIN AIRPORT (E16) CLASSIC HANGAR DETAILS

KEY
NEW
HANGAR ID
SIZE IN SQ FT
RATE CODE

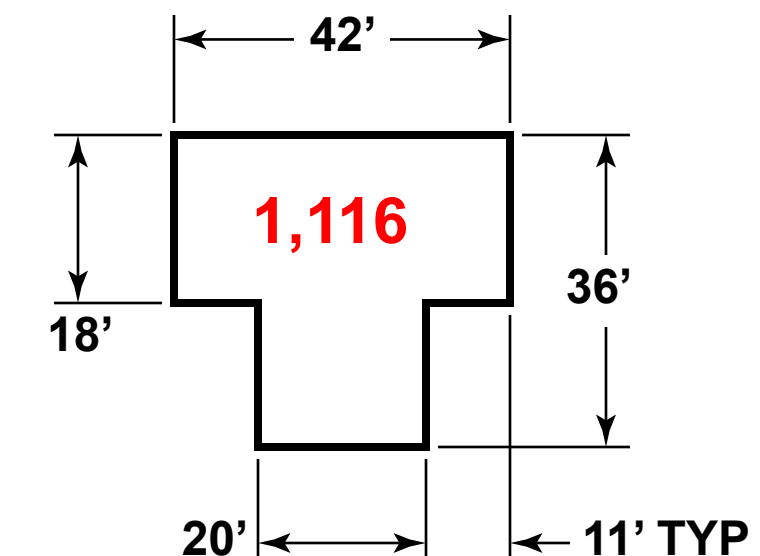

V2, V4, V6, V8
W3, W5, W7, W9

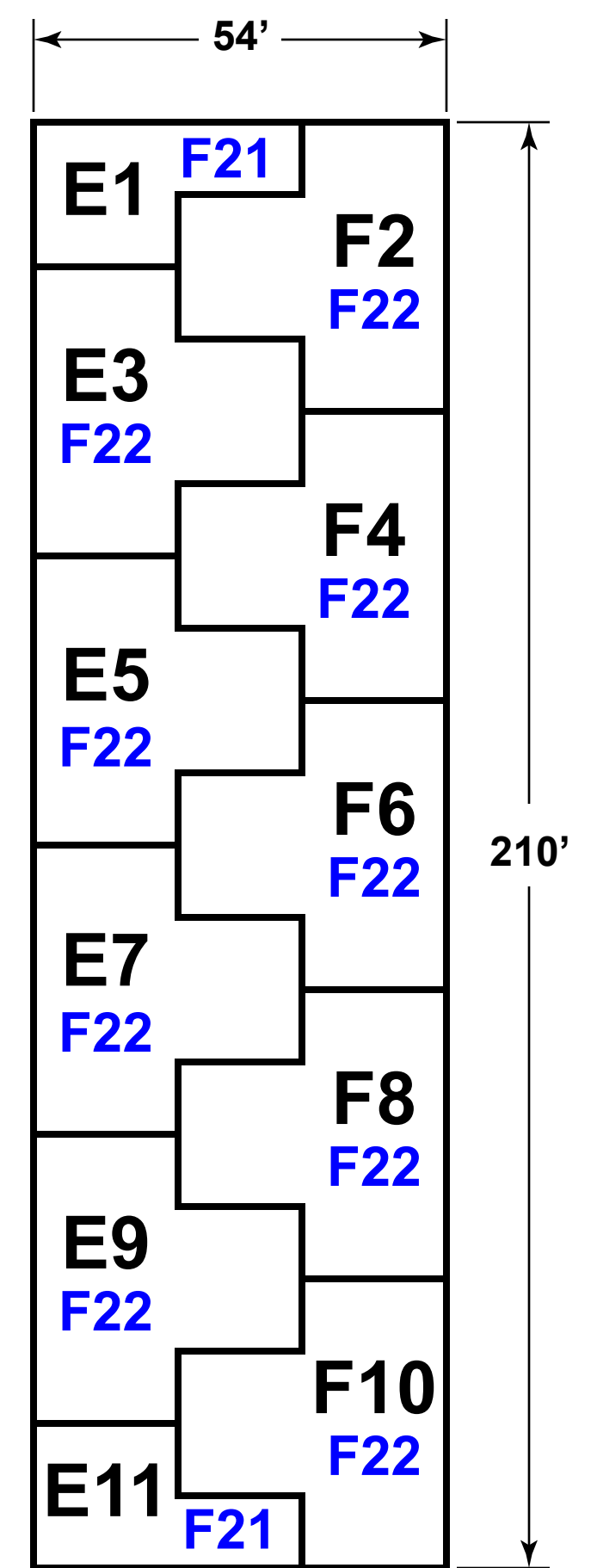
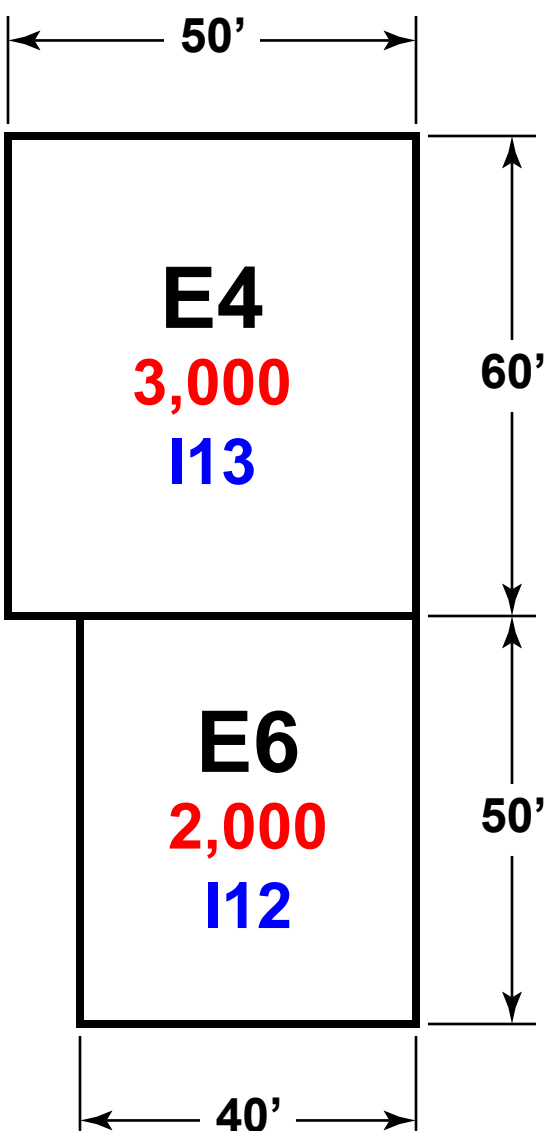
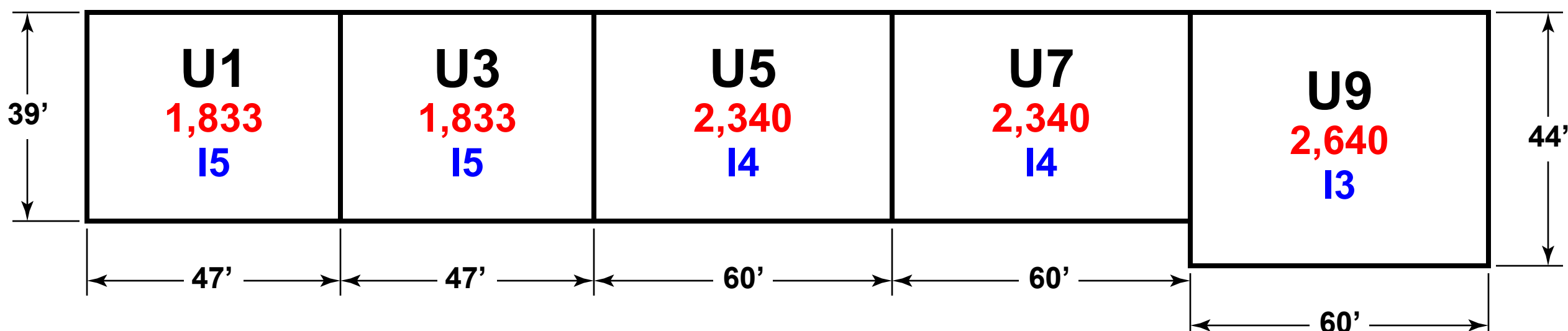
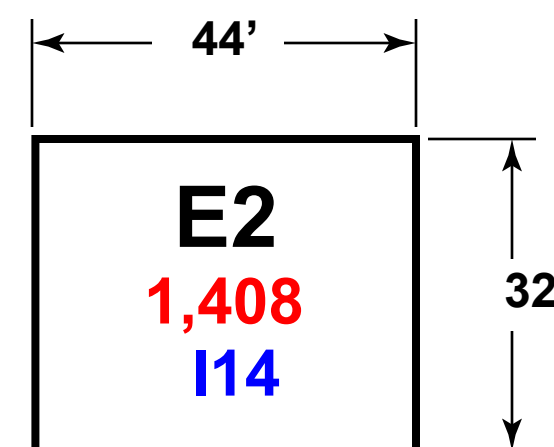
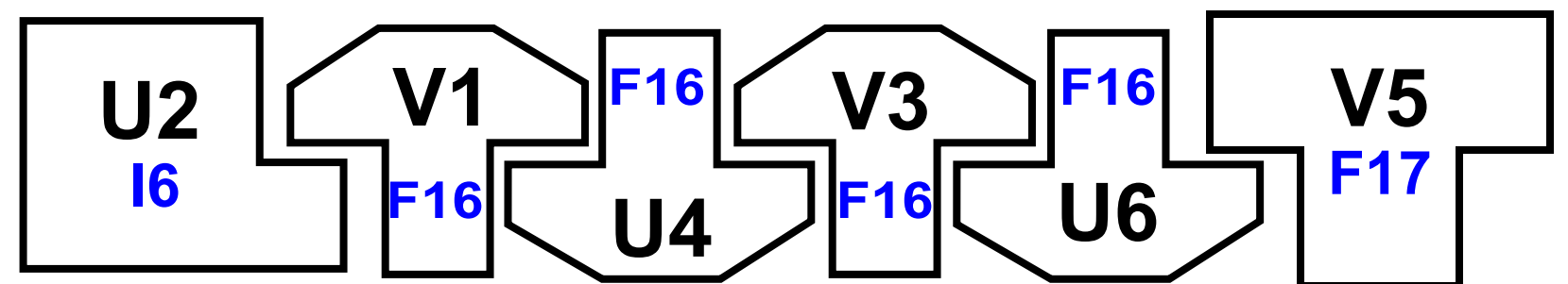
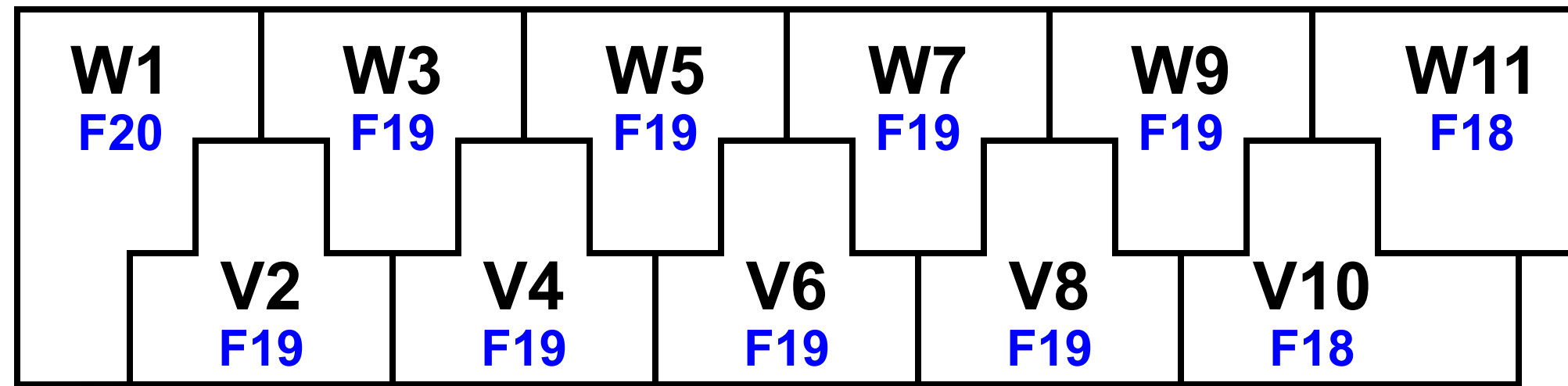
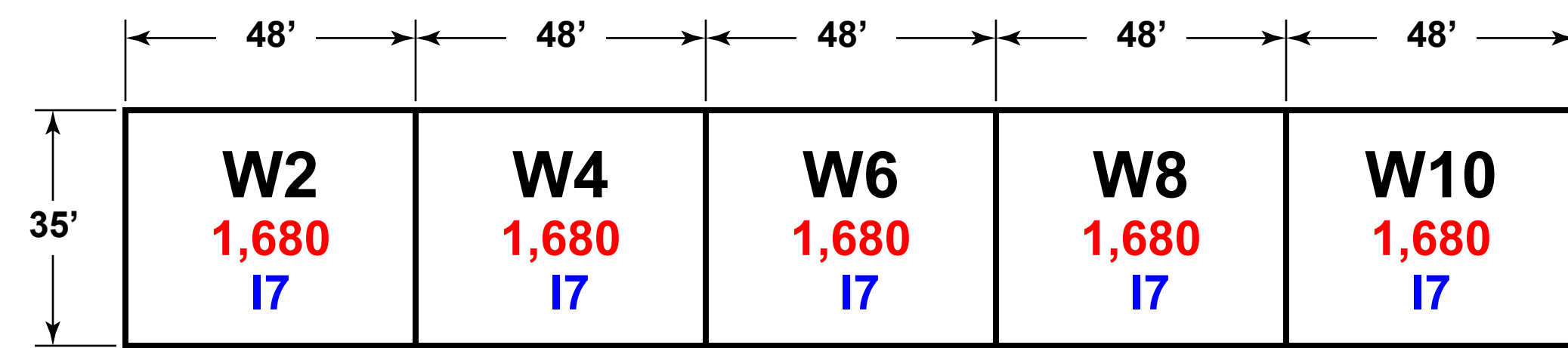
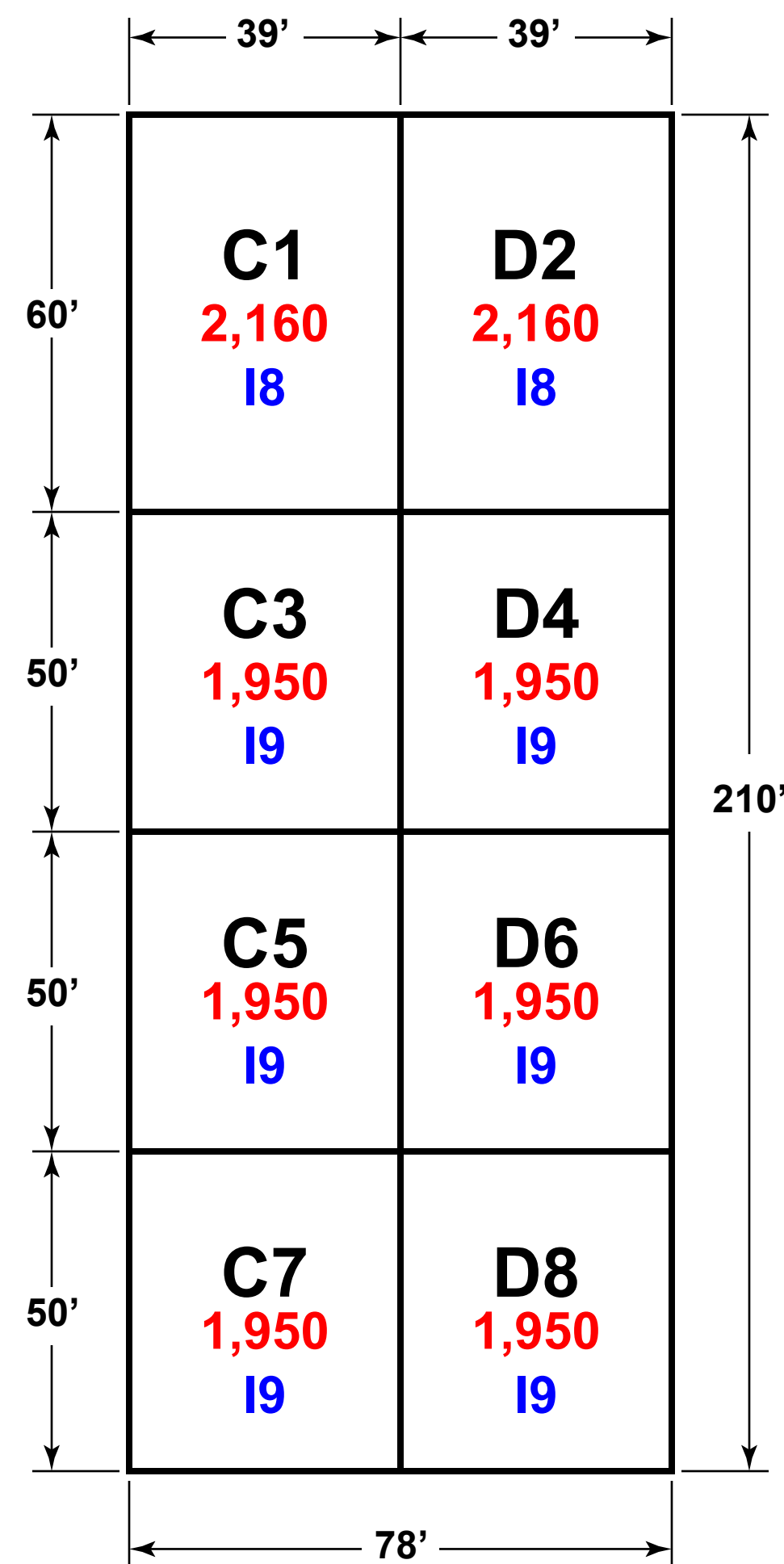
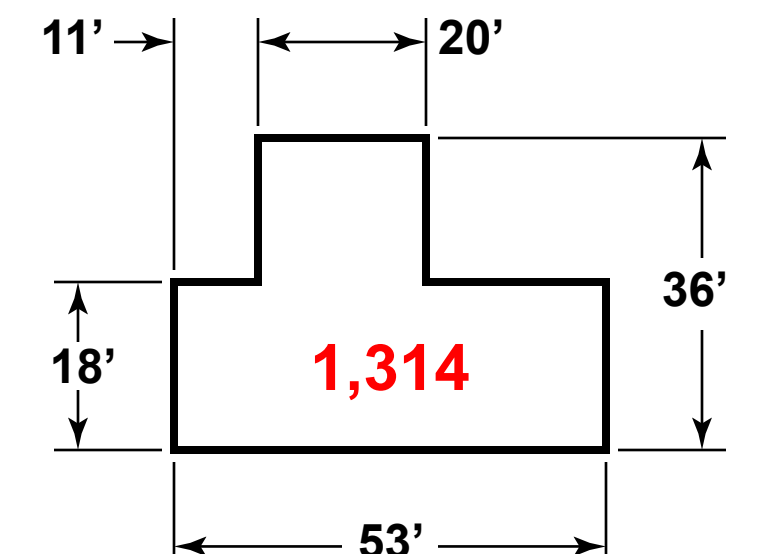

V10

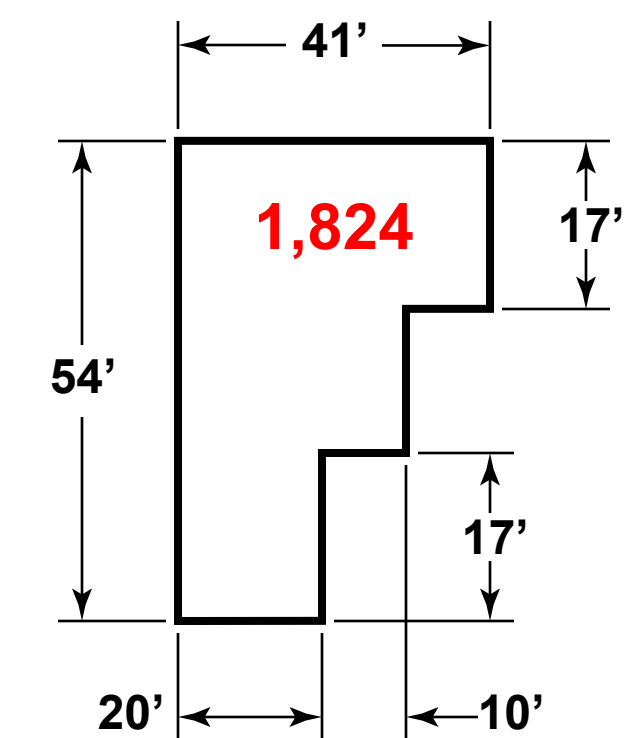

W1

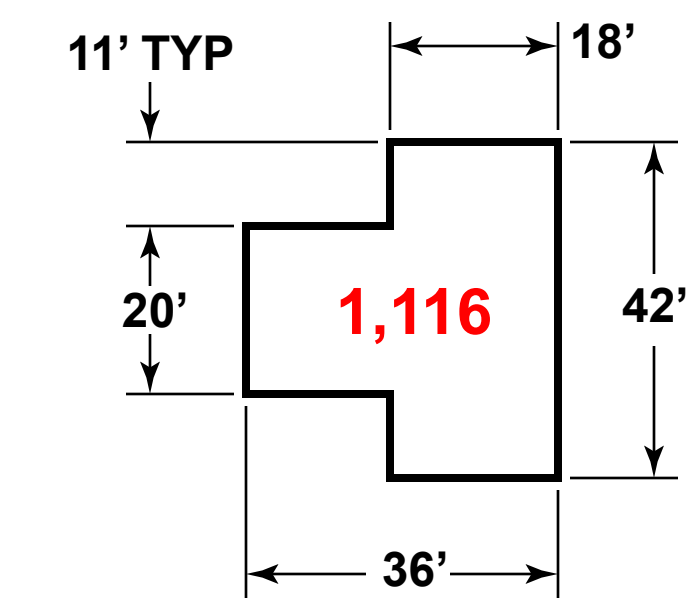
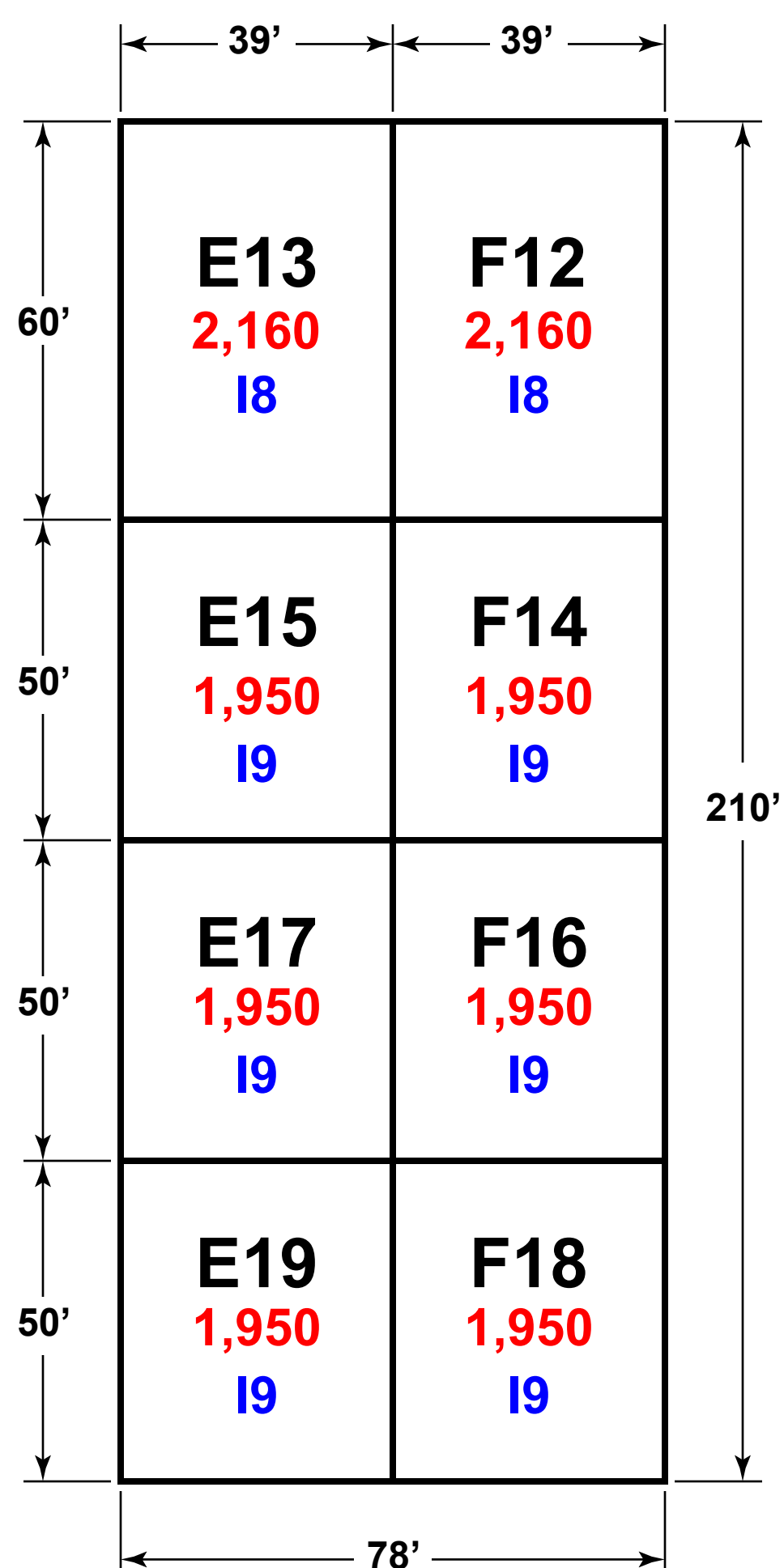

E3, E5, E7, E9, F2,
F4, F6, F8, F10

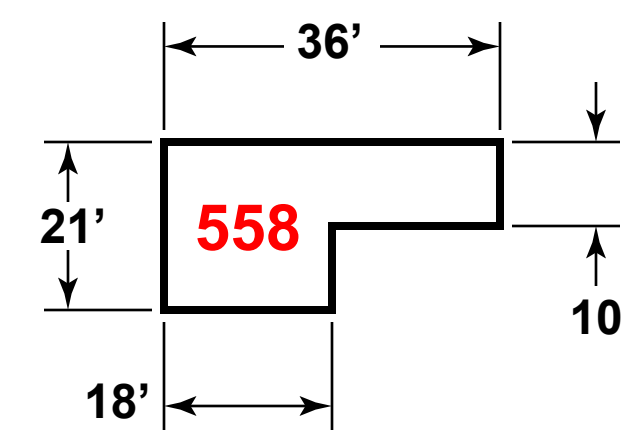

E1, E11

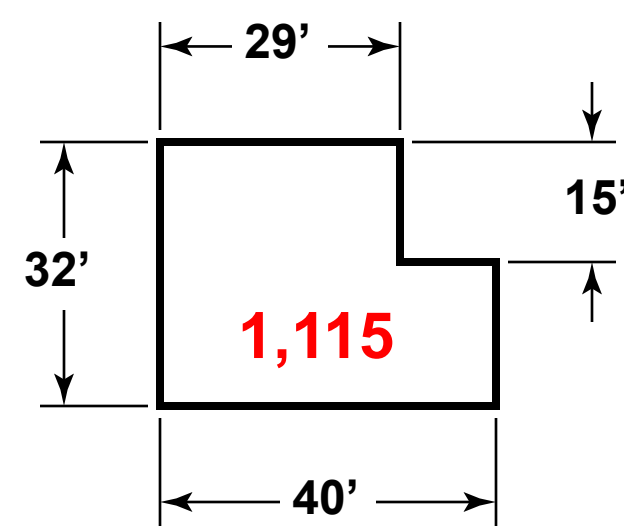

U2

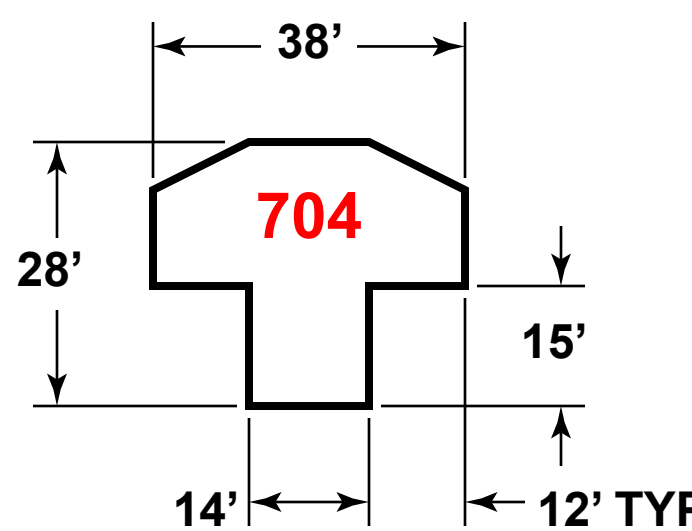

U4, U6, V1, V3

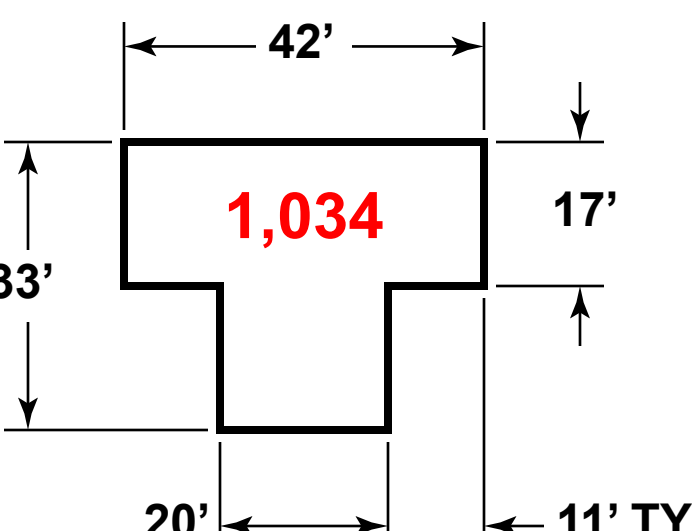

V5

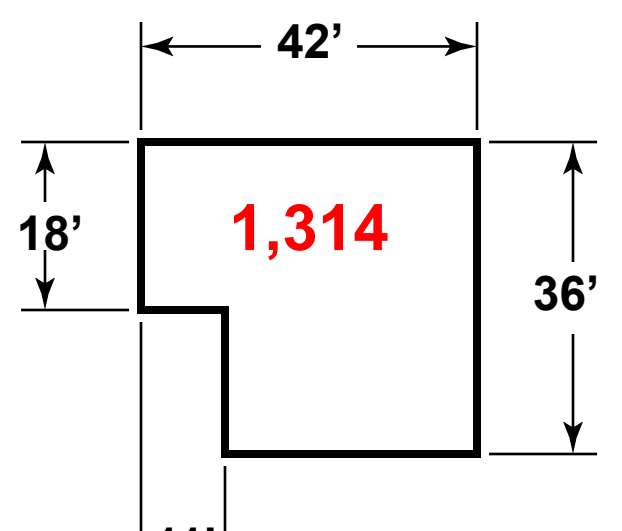

W11

NOTE:
NOT TO SCALE